



GA系列接插件技术特性 / GA technical characteristics



电流负载能力 / Current carrying capacity

电流负载能力所受的限制主要来自包含接插针的接插体可承受的最大温度。

测试和控制过程依据DINIEC 60512-3。

The current carrying is limited by maximum temperature of materials for inserts and contacts including terminals.

Control and test procedures according to DIN IEC 60512-3.

规范 / Specifications

DIN VDE 0627
DIN VDE 0110

接插件针数//Number of contacts 3,4,10,16,32(2x16)+PE

插接体 / Inserts

工作电流/Working current

GA-3, GA-4 10 A max.
GA-10, GA-16 16 A max.

(见负载图/See current carrying capacity)

工作电压/Working voltage

GA-3, GA-4 230/400V
GA-10, GA-16 250/400V

测试电压/Test voltage Urms

4KV

污染等级/Pollution degree

3(C)

当污染等级为2(C)时参数为/Pollution degree 2 also

16A 250/400V

隔离电阻/Insulation resistance

$\geq 10^{10} \Omega$

材料/Material

Polycarbonate

工作温度范围/Temperature range

-40°C...+100°C/125°C

阻燃等级(UL94)/Flammability acc.to (UI94)

V0

据UL/CSA工作电压/Working voltage acc.to UL/CSA

600V

可拨插次数/Mechanical working life(mating cycles)

≥ 500

接插针 / Contacts

材料/Material

铜/Copper alloy

表面处理/Surface

镀银/Hard silver-plated
镀金/Hard gold-plated

接触电阻/Contact resistance

$\geq 1 m \Omega$

接线形式/Terminal

螺钉压接或冷压针压接
Screw or Crimp terminal
-mm2 0.15-2.5mm²
-AWG 26-14

拧紧力矩/测试力矩 Tightening / test torque

0.25Nm GA-003, GA-004
0.5Nm GA-010, GA-016

金属上壳/底座 Hoods/Housings

材料/Material

铸铝合金/Die cast aluminium

表面处理/Surface

高温粉末镀层,灰色
Powder-coated, RAL 7037

锁定装置/Locking element

不锈钢或铁镀锌
Stainless steel, steel-zinc plated

工作温度范围/Temperature range

-40°C...+125°C

防护等级/Degree of protection acc.to DIN40 050

IP65

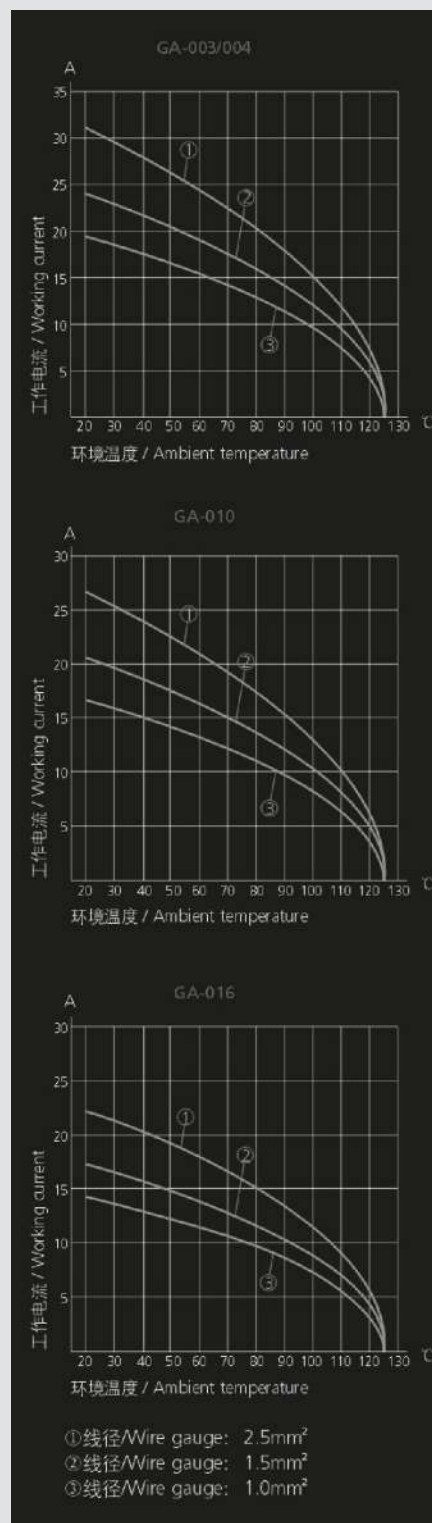

GA-003/GA-004接插体 / GA-003/GA-004 inserts



芯件适配用 G3A 外壳

Inserts suit for G3A hoods/housing

3+

4+

230V/400V/10A

3+

4+

螺钉压接 / Screw terminal



插芯/Inserts	型号/Type	订货号/Part Number
公 Male	GA-003-M	
母 Female	GA-003-F	



插芯/Inserts	型号/Type	订货号/Part Number
公 Male	GA-004-M	
母 Female	GA-004-F	

弹片压接 / Screw terminal



插芯/Inserts	型号/Type	订货号/Part Number
公 Male	GA-003-MS	
母 Female	GA-003-FS	



插芯/Inserts	型号/Type	订货号/Part Number
公 Male	GA-004-MS	
母 Female	GA-004-FS	

3+

4+

230V/400V/10A

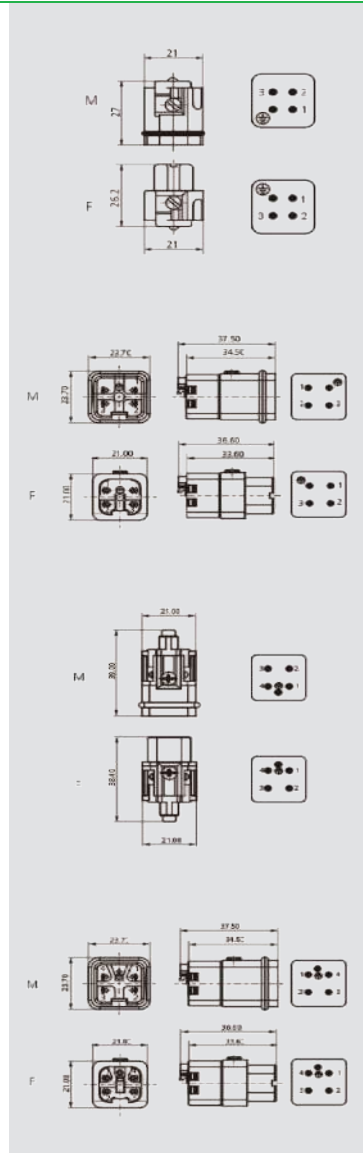

G3A塑料外壳 / G3A metal hoods/housings



底部外壳安装开孔尺寸 /Housing mounting dimensions PAGE/390

材质：聚碳酸酯

防护等级 Degree of protection : IP65

颜色：RAL7032

上壳 / Hoods

顶部进线 Top entry



螺纹 Thread	型号 /Type	订货号 /Part Number
PG11	G3A-MTG-P-PG11	
M20	G3A-MTG-P-M20	

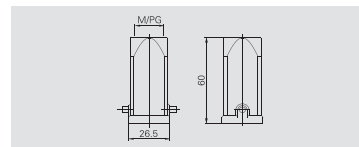

侧面进线 Side entry



螺纹 Thread	型号 /Type	订货号 /Part Number
PG11	G3A-MTS-P-PG11	
M20	G3A-MTS-P-M20	

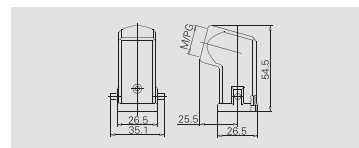

下壳底座 / Housings

开孔安装

Bulkhead mounting: Bottom entry



螺纹 Thread	型号 /Type	订货号 /Part Number
- - -	G3A-MAG-P	

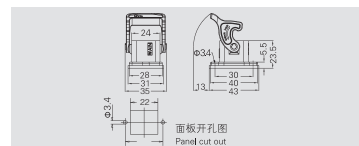

开孔安装(侧出形式)

Bulkhead mounting: Bottom entry



螺纹 Thread	型号 /Type	订货号 /Part Number
---	G3A-MAGS-P	

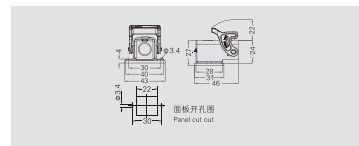

表面安装(侧面形式)

Surface mounting: Side entry



螺纹 Thread	型号 /Type	订货号 /Part Number
PG11	G3A-MAGSV-P-PG11	
M20	G3A-MAGSV-P-M20	

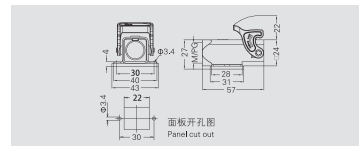

电缆对接下壳 Cable-to-cable hood:



螺纹 Thread	型号 /Type	订货号 /Part Number
PG11	G3A-MTGVB-P-PG11	
M20	G3A-MTGVB-P-M20	

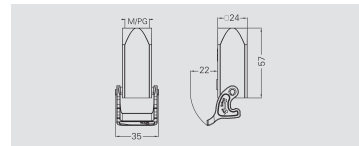

上壳保护盖 Protection covers for housings



螺纹 Thread	型号 /Type	订货号 /Part Number
⊘	配公芯 G3A-KDT-P/1M	
⊘	配母芯 G3A-KDT-P/1F	

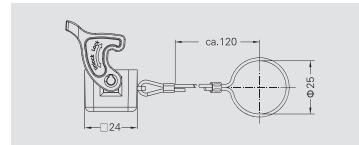

底座保护盖 Protection covers for housings



螺纹 Thread	型号 /Type	订货号 /Part Number
⊘	配公芯 G3A-KDB-P/1M	
⊘	配公芯 G3A-KDB-P/2M	
⊘	配母芯 G3A-KDB-P/1F	
⊘	配母芯 G3A-KDB-P/2F	

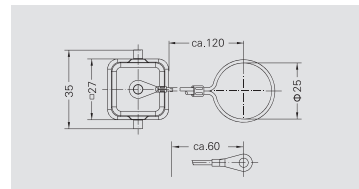

G3A金属外壳 / G3A metal hoods/housings

底部外壳安装开孔尺寸/Housing mounting dimensions PAGE/390

表面粉末镀层,RAL7037 / Powder-coated,RAL 7037

防护等级 Degree of protection : IP65

上壳 / Hoods

顶部进线 Top entry



螺纹 Thread	型号/Type	订货号 /Part Number
PG11	G3A-MTG-PG11	
M20	G3A-MTG-M20	



螺纹 Thread	型号/Type	订货号 /Part Number
M25	G3A-MTG-M25	

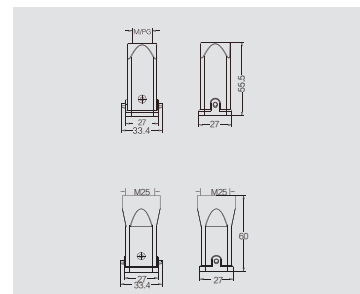

侧面进线 Side entry



螺纹 Thread	型号/Type	订货号 /Part Number
PG11	G3A-MTS-PG11	
M20	G3A-MTS-M20	
M25	G3A-MTS-M25	

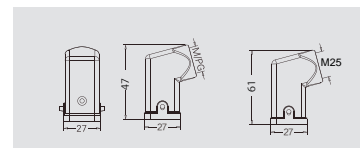

下壳底座 / Housings

开孔安装

Bulkhead mounting: Bottom entry



螺纹 Thread	型号/Type	订货号 /Part Number
	G3A-MAG-12/2	



螺纹 Thread	型号/Type	订货号 /Part Number
---	G3A-MAG	



螺纹 Thread	型号/Type	订货号 /Part Number
---	G3A-MAG-AD	

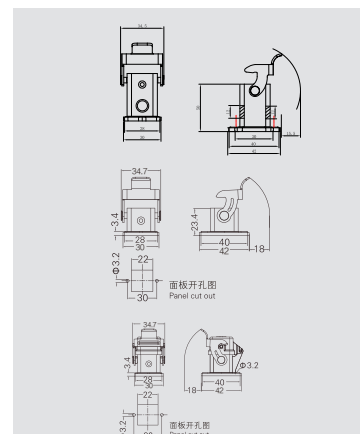

开孔安装(侧出形式)

Bulkhead mounting: Bottom entry



螺纹 Thread	型号/Type	订货号 /Part Number
---	G3A-MAGS	

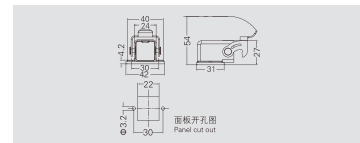

表面安装(侧面形式)

Surface mounting: Side entry



螺纹 Thread	型号/Type	订货号 /Part Number
PG11	G3A-MAGSV-PG11	
M20	G3A-MAGSV-M20	

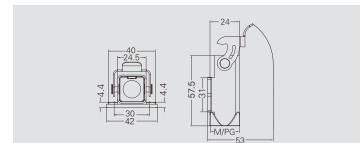

电缆对接下壳 Cable-to-cable hood:



螺纹 Thread	型号/Type	订货号 /Part Number
PG11	G3A-MTGVB-PG11	
M20	G3A-MTGVB-M20	

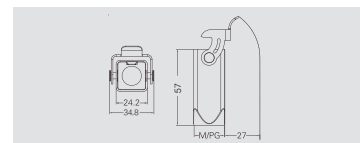

G3A金属外壳 EMC / G3A metal hoods/housings



底部外壳安装开孔尺寸/Housing mounting dimensions PAGE/390

表面粉末镀层,RAL7037 / Powder-coated,RAL 7037

保护盖

上壳保护盖
Protection covers for housings



螺纹 Thread	型号/Type	订货号 /Part Number
	配公芯 G3A-KDT-LA/1M	
	配母芯 G3A-KDT-LA/1F	

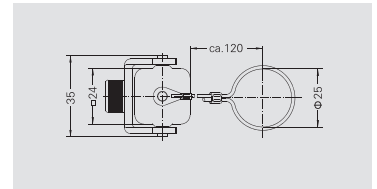

底座保护盖
Protection covers for housings



螺纹 Thread	型号/Type	订货号 /Part Number
	配公芯 G3A-KDB-LA/1M	
	配公芯 G3A-KDB-LA/2M	
	配母芯 G3A-KDB-LA/1F	
	配母芯 G3A-KDB-LA/2F	

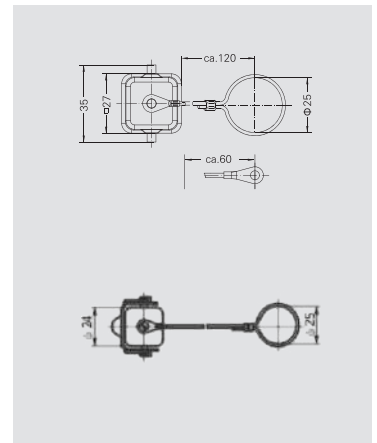

螺纹 Thread	型号/Type	订货号 /Part Number
---	G3A-KDB	

G3A高防护金属外壳 / G3A metal hoods/housings

防护等级Degree of protection: IP68 H version

喷涂/镀铬 Epoxy power paint/Chromated

上壳 / Hoods

顶部进线 Top entry



螺纹 Thread	型号/Type	订货号 /Part Number
PG13.5	G3A-MTGH-HP-PG13.5	
M20	G3A-MTGH-HP-M20	

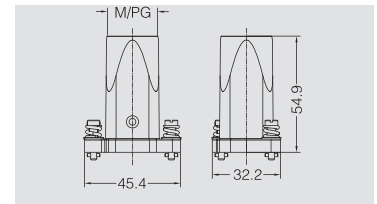

下壳底座 / Housings

开孔安装
Bulkhead mounting: Bottom entry



螺纹 Thread	型号/Type	订货号 /Part Number
	G3A-MAGH-HP	

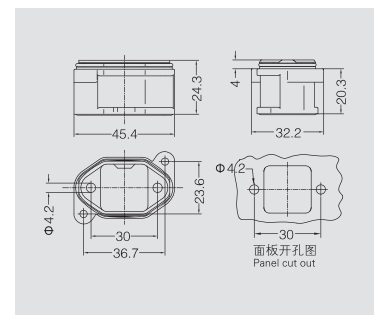

GA-010 接插体 / GA-010 inserts



芯件适配用G10A外壳

Inserts suit for G10A hoods/housing

10+

螺钉压接 / Screw terminal



250V max.16A

插芯/Inserts	型号/Type	订货号/Part Number
公 Male	GA-010-M	
母 Female	GA-010-F	

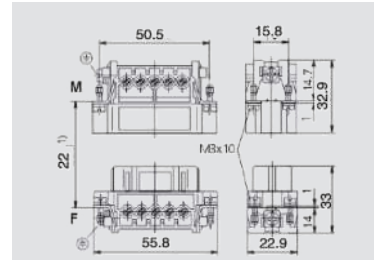

1) 接插体之间最大距离24mm
Distance for contact max.24mm

冷压针压接/Crimp terminal

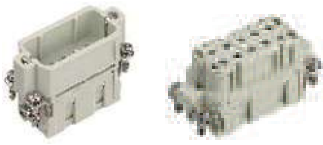

250V max.10A

插芯/Inserts	型号/Type	订货号/Part Number
公 Male	GA-010-MC	
母 Female	GA-010-FC	

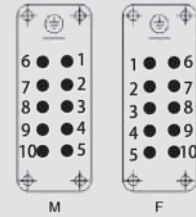

接插针排序
Contacts arrangement view from termination side

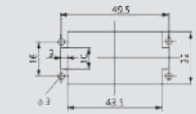

板面安装开孔图
Panel cut out for use without hoods/housings

冷压接插针 Crimp contacts

技术参数/Technical data

材料: 铜

Material: copper

接触电阻/Contact resistance: $\leq 3m\Omega$

接线形式: 冷压工具压接

Terminal: crimp connection

(镀银)冷压接插针/Crimp contacts.silver-platea

标识 Identification	线规 Wire gauge	剥线长度 Stripping length	公插针 Male	订货号 Part Number	母插针 Female	订货号 Part Number	内孔直径
no groove	0.5 mm ²	AWG 20	8.0m m	CDM-0.5	CDF-0.5		1.15
1 groove	0.75 mm ²	AWG 18	8.0m m	CDM-0.75	CDF-0.75		1.3
1 groove	1.0 mm ²	AWG 18	8.0m m	CDM-1.0	CDF-1.0		1.45
2 groove	1.5 mm ²	AWG 16	8.0m m	CDM-1.5	CDF-1.5		1.75
3 groove	2.5 mm ²	AWG 14	8.0m m	CDM-2.5	CDF-2.5		2.25

(镀金)冷压接插针/Crimp contacts.Gold-plated

标识 Identification	线规 Wire gauge	剥线长度 Stripping length	公插针 Male	订货号 Part Number	母插针 Female	订货号 Part Number	内孔直径
no groove	0.5 mm ²	AWG 20	8.0m m	DDM-0.5	DDF-0.5		1.15
1 groove	0.75 mm ²	AWG 18	8.0m m	DDM-0.75	DDF-0.75		1.3
1 groove	1.0 mm ²	AWG 18	8.0m m	DDM-1.0	DDF-1.0		1.45
2 groove	1.5 mm ²	AWG 16	8.0m m	DDM-1.5	DDF-1.5		1.75
3 groove	2.5 mm ²	AWG 14	8.0m m	DDM-2.5	DDF-2.5		2.25

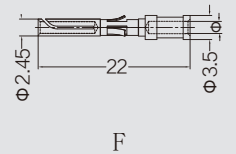
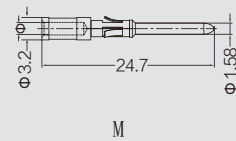

工具 Tools

冷压钳 Manual hydraulic clamp



退针器 Removal tool



压接线径 Wire gauge	型号/Type	订货号/Part Number
0.5-4mm ²	CRIMPBOX-0.5/4	

适用类型 For	型号/Type	订货号/Part Number
10A 冷压针 Crimp contacts	REMOV-GD	

G10A外壳/ G10A with 1 lever on the hoods/housings



底部外壳安装开孔尺寸/Housing mounting dimensions PAGE/390

表面粉末镀层, RAL 7037 / Powder-coated, RAL 7037

防护等级Degree of protection: IP65

上壳 / Hoods

侧面进线 Side entry



螺纹 Thread	型号/Type	订货号 /Part Number
PG16	G10A-TS-RO-PG16	
M20	G10A-TS-RO-M20	



高结构/High construction		
PG21	G10A-TSH-RO-PG21	
M25	G10A-TSH-RO-M25	

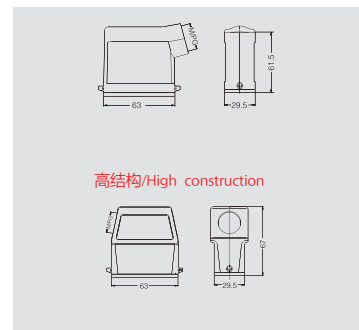

顶部进线: Top entry



螺纹 Thread	型号/Type	订货号 /Part Number
PG16	G10A-TG-RO-PG16	
M20	G10A-TG-RO-M20	



高结构/High construction		
PG21	G10A-TGH-RO-PG21	
M25	G10A-TGH-RO-M25	

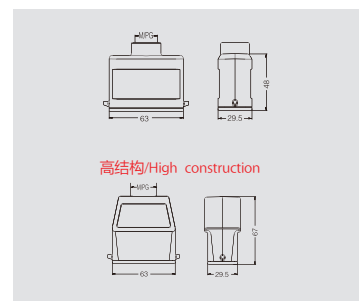

下壳底座 / Housings

外壳底座: 开孔安装 Bulkhead mounted housing



螺纹 Thread	型号/Type	订货号 /Part Number
	G10A-AG-LB	
	带保护盖 With protection cover	
	G10A-AD-LB	

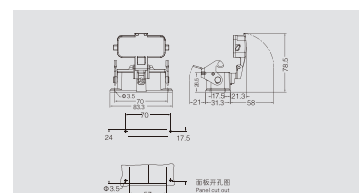

外壳底座: 表面安装 Surface mounting: Side entry



螺纹 Thread	型号/Type	订货号 /Part Number
1个进线孔1 Side entry		
PG16	G10A-SGR-LB-PG16	
M20	G10A-SGR-LB-M20	
PG21	G10A-SGR-LB-PG21	
2个进线孔2 Side entry		
PG16	G10A-SGR-LB-2PG16	
M20	G10A-SGR-LB-2M20	
PG21	G10A-SGR-LB-2PG21	

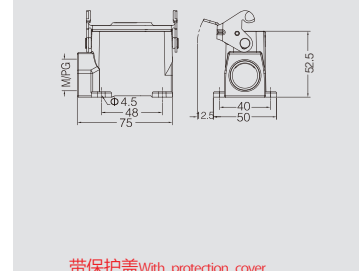

带保护盖 With protection cover		
1个进线孔1 Side entry		
PG16	G10A-SDR-LB-PG16	
PG21	G10A-SDR-LB-PG21	
M20	G10A-SDR-LB-M20	
M25	G10A-SDR-LB-M25	
2个进线孔2 Side entry		
PG16	G10A-SDR-LB-2PG16	
PG21	G10A-SDR-LB-2PG21	
M20	G10A-SDR-LB-2M20	
M25	G10A-SDR-LB-2M25	

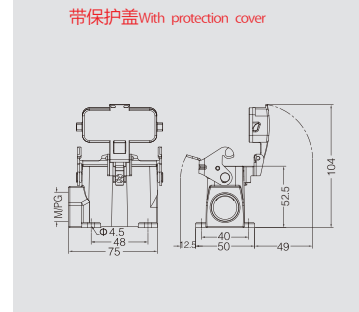

GA-016接插体 / GA-016 inserts



芯件适配用G16A外壳

Inserts suit for G16A hoods/housing

螺钉压接/Screw terminal

250V max.16A

16+

螺钉压接/ Screw terminal



250V max.16A

插芯/Inserts	型号/Type	订货号/Part Number
公 Male	GA-016-M	
母 Female	GA-016-F	

冷压针压接/Crimp terminal



250V max.10A

插芯/Inserts	型号/Type	订货号/Part Number
公 Male	GA-016-MC	
母 Female	GA-016-FC	

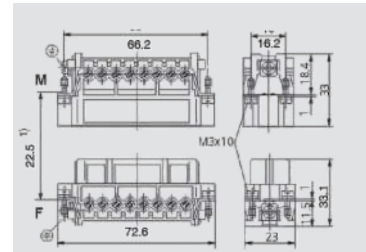

1)接插体之间最大距离24mm
Distance for contact max.24mm



接插针排序

Contacts arrangement view from termination side

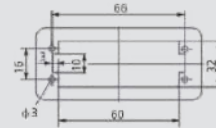

板面安装开孔图

Panel cut out for use without hoods/housings

冷压接插针 Crimp contacts

技术参数/Technical data

材料: 铜

Material: copper

接触电阻/Contact resistance: $\leq 3m\Omega$

接线形式: 冷压工具压接

Terminal: crimp connection

(镀银)冷压接插针/Crimp contacts.silver-platea

标识 Identification	线规 Wire gauge	剥线长度 Stripping length	公插针 Male	订货号 Part Number	母插针 Female	订货号 Part Number	内孔 直径
no groove	0.5 mm ²	AWG 20	8.0m m	CDM-0.5	CDF-0.5		1.15
1 groove	0.75 mm ²	AWG 18	8.0m m	CDM-0.75	CDF-0.75		1.3
1 groove	1.0 mm ²	AWG 18	8.0m m	CDM-1.0	CDF-1.0		1.45
2 groove	1.5 mm ²	AWG 16	8.0m m	CDM-1.5	CDF-1.5		1.75
3 groove	2.5 mm ²	AWG 14	8.0m m	CDM-2.5	CDF-2.5		2.25

(镀金)冷压接插针/Crimp contacts.Gold-plated

标识 Identification	线规 Wire gauge	剥线长度 Stripping length	公插针 Male	订货号 Part Number	母插针 Female	订货号 Part Number	内孔 直径
no groove	0.5 mm ²	AWG 20	8.0m m	DDM-0.5	DDF-0.5		1.15
1 groove	0.75 mm ²	AWG 18	8.0m m	DDM-0.75	DDF-0.75		1.3
1 groove	1.0 mm ²	AWG 18	8.0m m	DDM-1.0	DDF-1.0		1.45
2 groove	1.5 mm ²	AWG 16	8.0m m	DDM-1.5	DDF-1.5		1.75
3 groove	2.5 mm ²	AWG 14	8.0m m	DDM-2.5	DDF-2.5		2.25

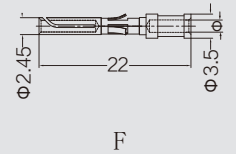
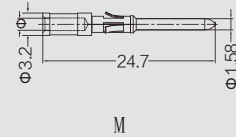

工具 Tools

冷压钳 Manual hydraulic clamp



退针器 Removal tool



压接线径 Wire gauge	型号/Type	订货号/Part Number
0.5-4mm ²	CRIMPBOX-0.5/4	

适用类型 For	型号/Type	订货号/Part Number
10A 冷压针 Crimp contacts	REMOV-GD	

G16A外壳 / G16A with 1 lever on the hoods/housings



底部外壳安装开孔尺寸/Housing mounting dimensions PAGE/390

表面粉末镀层, RAL 7037 / Powder-coated, RAL 7037

防护等级Degree of protection:IP65

上壳 / Hoods

侧面进线 Side entry



螺纹 Thread	型号/Type	订货号 /Part Number
PG16	G16A-TS-RO-PG16	
M20	G16A-TS-RO-M20	

高结构/High construction

PG21	G16A-TSH-RO-PG21	
M25	G16A-TSH-RO-M25	
M32	G16A-TSH-RO-M32	

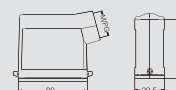

高结构/High construction

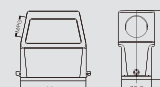

顶部进线: Top entry



螺纹 Thread	型号/Type	订货号 /Part Number
PG16	G16A-TG-RO-PG16	
M20	G16A-TG-RO-M20	

高结构/High construction

PG21	G16A-TGH-RO-PG21	
M25	G16A-TGH-RO-M25	

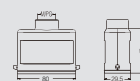

高结构/High construction

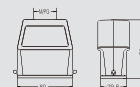

下壳底座 / Housings

外壳底座: 开孔安装 Bulkhead mounted housing



螺纹 Thread	型号/Type	订货号 /Part Number
	G16A-AG-LB	
	带保护盖With protection cover	
	G16A-AD-LB	

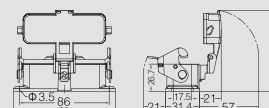
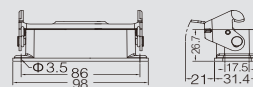

外壳底座: 表面安装 Surface mounting: Side entry



螺纹 Thread	型号/Type	订货号 /Part Number
	1个进线孔1Side entry	

PG16	G16A-SGR-LB-PG16	
M20	G16A-SGR-LB-M20	
M25	G16A-SGR-LB-M25	
PG21	G16A-SGR-LB-PG21	

PG16	G16A-SGR-LB-2PG16	
M20	G16A-SGR-LB-2M20	
M25	G16A-SGR-LB-2M25	
PG21	G16A-SGR-LB-2PG21	

带保护盖With protection cover

PG16	G16A-SDR-LB-PG16	
M20	G16A-SDR-LB-M20	
M25	G16A-SDR-LB-M25	
PG21	G16A-SDR-LB-PG21	

PG16	G16A-SDR-LB-2PG16	
PG21	G16A-SDR-LB-2PG21	
M20	G16A-SDR-LB-2M20	
M25	G16A-SDR-LB-2M25	

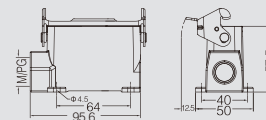

带保护盖With protection cover

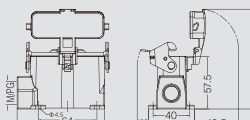

G32A外壳 / G32A with 2 lever on the hoods/housings



底部外壳安装开孔尺寸/Housing mounting dimensions PAGE/390

表面粉末镀层, RAL 7037 / Powder-coated, RAL 7037

防护等级Degree of protection: IP65

上壳 / Hoods

侧面进线 Side entry



螺纹 Thread	型号/Type	订货号 /Part Number
PG21	G32A-TSS-PG21	
M25	G32A-TSS-M25	

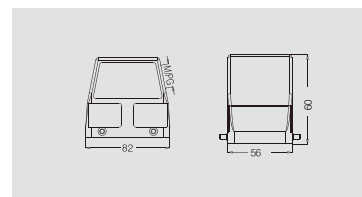

螺纹 Thread	型号/Type	订货号 /Part Number
PG21	G32A-TS-PG21	
PG29	G32A-TS-PG29	
M25	G32A-TS-M25	
M32	G32A-TS-M32	

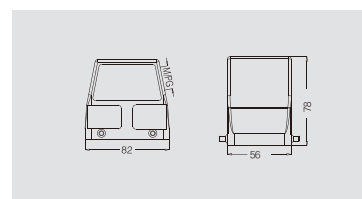
外壳上壳: 顶部进线
Hood: Top entry

螺纹 Thread	型号/Type	订货号 /Part Number
PG21	G32A-TG-PG21	
PG29	G32A-TG-PG29	
M25	G32A-TG-M25	
M32	G32A-TG-M32	
M40	G32A-TG-M40	

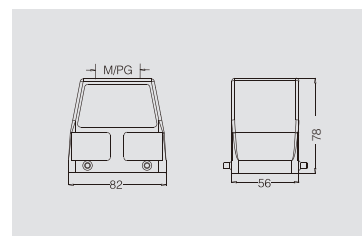

下壳底座 / Housings

外壳底座: 开孔安装
Bulkhead mounted housing

螺纹 Thread	型号/Type	订货号 /Part Number
	G32A-AG	

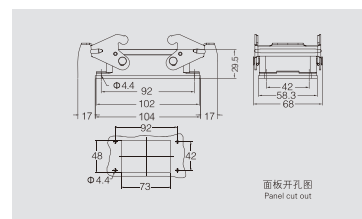
外壳底座: 表面安装
Surface mounting: Side entry

螺纹 Thread	型号/Type	订货号 /Part Number
1个进线孔1 Side entry		
PG21	G32A-SGR-PG21	
PG29	G32A-SGR-PG29	
M25	G32A-SGR-M25	
M32	G32A-SGR-M32	
2个进线孔2 Side entry		
PG21	G32A-SGR-2PG21	
PG29	G32A-SGR-2PG29	
M25	G32A-SGR-2M25	
M32	G32A-SGR-2M32	

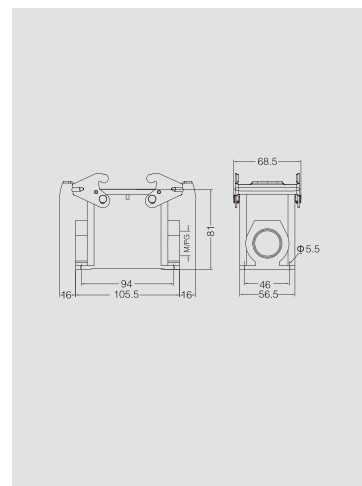

G32A外壳 / G32A with 2 lever on the hoods/housings

底部外壳安装开孔尺寸/Housing mounting dimensions PAGE/390

表面粉末镀层, RAL 7037 / Powder-coated, RAL 7037

防护等级Degree of protection: IP65

上壳 / Hoods

侧面进线 Side entry



螺纹 Thread	型号/Type	订货号 /Part Number
PG21	G32A-TSB-PG21	
PG29	G32A-TSB-PG29	
M25	G32A-TSB-M25	
M32	G32A-TSB-M32	

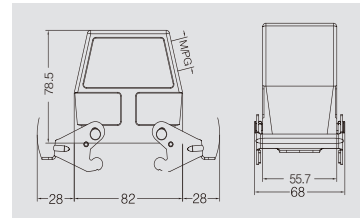

外壳上壳: 顶部进线 Hood: Top entry



螺纹 Thread	型号/Type	订货号 /Part Number
PG21	G32A-TGB-PG21	
PG29	G32A-TGB-PG29	
M25	G32A-TGB-M25	
M32	G32A-TGB-M32	
M40	G32A-TGB-M40	

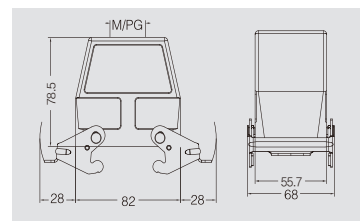

下壳底座 / Housings

外壳底座: 开孔安装 Bulkhead mounted housing



螺纹 Thread	型号/Type	订货号 /Part Number
	G32A-AG-BO	
	带保护盖 With protection cover	
	G32A-AD-BO	

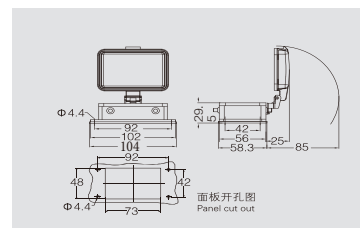

外壳底座: 表面安装 Surface mounting: Side entry



螺纹 Thread	型号/Type	订货号 /Part Number
1个进线孔1 Side entry		
PG21	G32A-SGR-BO-PG21	
PG29	G32A-SGR-BO-PG29	
M25	G32A-SGR-BO-M25	
M32	G32A-SGR-BO-M32	
2个进线孔2 Side entry		
PG21	G32A-SGR-BO-2PG21	
PG29	G32A-SGR-BO-2PG29	
M25	G32A-SGR-BO-2M25	
M32	G32A-SGR-BO-2M32	
带保护盖 With protection cover		
1个进线孔1 Side entry		
PG21	G32A-SDR-BO-PG21	
PG29	G32A-SDR-BO-PG29	
M25	G32A-SDR-BO-M25	
M32	G32A-SDR-BO-M32	
2个进线孔2 Side entry		
PG21	G32A-SDR-BO-2PG21	
PG29	G32A-SDR-BO-2PG29	
M25	G32A-SDR-BO-2M25	
M32	G32A-SDR-BO-2M32	

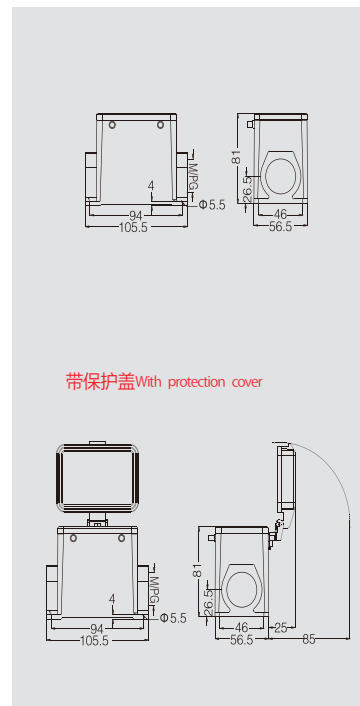

带保护盖 With protection cover